

Attic Stairs

Installation Instructions

Important

Strong springs aid the operation of these stairs! Care must be exercised during installation and operation so these springs are not released in an uncontrolled manner as this could lead to damage to the stair or personal injury to the operator/installer.

Tools Required

The Timbertight screws supplied with this stair require a 5/16" socket for easy installation. This can be used with a 9 volt (or stronger) battery drill or a standard power drill. Apart from this only standard carpentry tools are required.

Choosing the Location

When choosing the location for the installation of the attic stair a compromise between where you would like it to be located in relation to the floor plan and what is possible in relation to the roof structure may be required. The considerations for this compromise are set out below.

1. Choose a location that will give good headroom at the top of the stairs.
2. Choose a location with good access at the bottom of the stairs.
3. Choose a location that will allow for movement around the stair when in the down position.
4. Allowance must be made for the operation of the stairs, as they require a greater space to open than indicated by the opening in the ceiling (figure 1). *All dimensions in mm.*

Model	Required Opening	Landing Space	Projection
R36	1440 x 650	1480	2100

5. The area for the opening must be clear of wiring, plumbing and structural members such as beams and trusses with a minimum clear height above the ceiling of 640mm (figure 2).

Preparing the Opening

1. Mark out on the ceiling the opening required in the selected position. Then cut out the ceiling lining ensuring that the opening is square.
2. Using timber of a compatible size to the existing ceiling framing, ie 100 x 50 or 150 x 50 H1 treated, machine gauged radiata pine, frame up the opening. It may be necessary to cut through some existing ceiling joists to achieve the required size. Ensure these are properly supported during and after cutting. Three possible arrangements are shown in figures 3, 4 and 5.
3. **DO NOT CUT TRUSSES** without engineering approval.

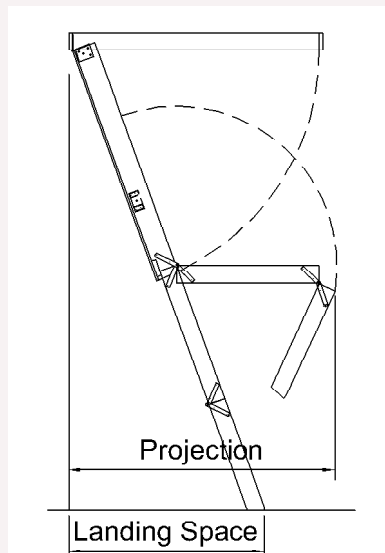

fig 1

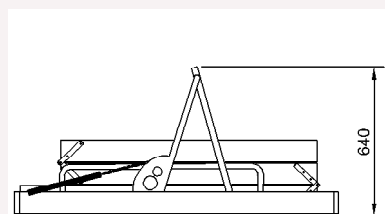

fig 2

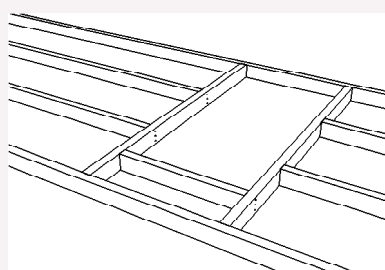

fig 3

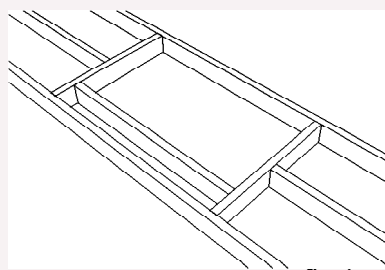

fig 4

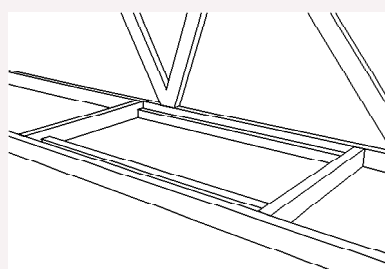

fig 5

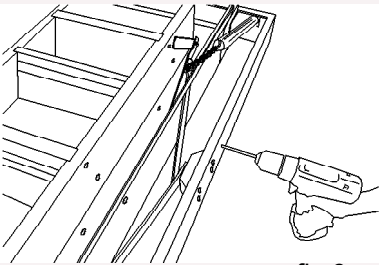

fig 6

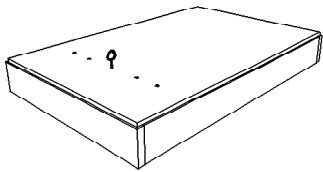

fig 7

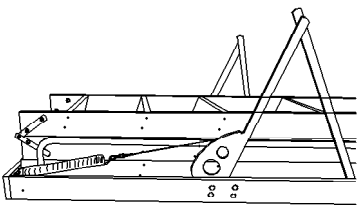

fig 8

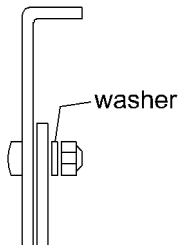

fig 9

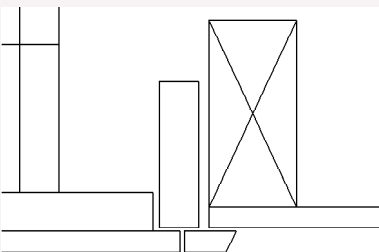

fig 10

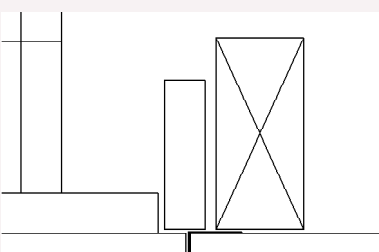

fig 11

Preparing the Stairs

1. Remove the stair from its packaging and place it lid down on a bench or saw stool. It's less likely to damage the lid there than laying it on the ground as well as being better for your back!
2. Drill 4 x 6mm (1/4") holes in the outside frame in the following positions:-
 - One in each side of frame near the blocks that hold the stays on to the side frame
 - One in each frame side 160mm in from the opening end.

These holes must be positioned so the screws going through them will fix into solid timber (figure 6). They will be 45 – 60mm from the bottom of the frame.

3. Turn the lid over so the lid is facing up.
4. You may choose to prepare the lid for painting by filling and sanding the screw holes now as it is easier now than later, when the unit is in the ceiling.
5. Fit the screw eye which is taped to the operating rod to the lid 60mm in from the opening end, midway across the width (figure 7).
6. **The R36 stair requires some assembly before installation**

To enable ease of transport the arms of the R36 attic stair are disassembled before packing and need to be joined together again before the stair is installed (figure 8).

To assemble the arms:

- a) Fold out the arm with the tie wire attached. Ensure the end of the wire is securely engaged in notch.
- b) Attach the chain to the spring using the link in the chain that is nearest the spring. Make sure the wire stays in the groove running round the edge of the banjo stay.
- c) Fold out the arm with the bolt, washer and nut attached. Remove the nut and feed the bolt through the 8mm hole in the end of the arm with the wire attached making sure the washer is next to the nylok nut (figure 9). There is now some tension on the spring.
- d) The arm with the wire must be on the outside.
- e) Tighten the nut tight and then release half a turn so the arms will move easily.

Repeat on the other side. These moving joints may require lubricating periodically

Installing the stairs

Note; The stairs are designed to be installed with the outside frame flush with the underside of the ceiling lining. An architrave will cover the gap between the stair frame and the ceiling lining while also hiding the edge of the lid from view (figure 10).

Optional; If the stair is to be installed as the house is being built and before the ceiling lining is fitted you may choose to fit the stair frame flush with the bottom of the ceiling battens (figure 11). A "J" channel is then fitted to the stair frame and ceiling lining fitted into the "J" frame to achieve a square stop finish.

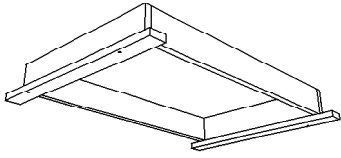

fig 12

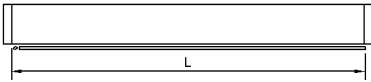

fig 13

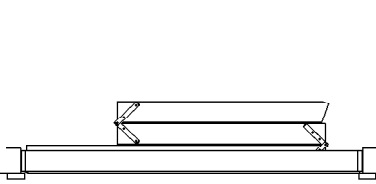

fig 14

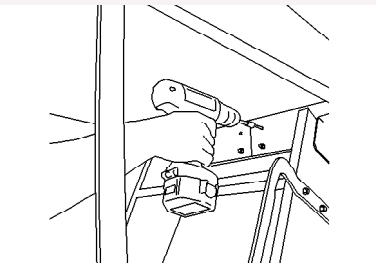

fig 15

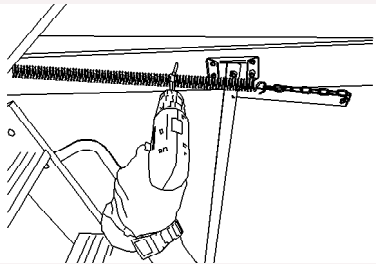

fig 16

1. Screw two temporary cleats that are the full width of the opening to the ceiling (figure 12). Fix one cleat at the hinge end protruding 15mm into the opening. The other, at the opening end, must protrude 15mm into the opening also. The distance between these cleats must be $L + 10\text{mm}$ as seen in figure 13.

The cleats must be securely fixed as they carry the full weight of the stairs

Note; If the stairs are to be installed before the ceiling lining is in place, the cleats must be packed down the thickness of the intended ceiling lining unless a "J" channel is being used.

2. Lift the stairs through the opening into the attic space. Then lower them down squarely into the opening so the frame of the stair rests on the temporary cleats (figure 14). This is normally best done from below and can be done by one person, but it is very much easier and safer with two people.
3. Check and confirm there is plenty of frame sitting on the cleats before proceeding further. Adjust if necessary. **The stairs must not be allowed to fall, as this could cause SERIOUS PHYSICAL DAMAGE.**
4. Carefully open the stair, checking that the frame remains securely on the cleats. Adjust if necessary. **DO NOT PUT ANY WEIGHT ON THE STAIR AT THIS STAGE.**
5. From a step ladder or saw stool or similar (not the attic stair), fix the hinge end of the stair to the ceiling framing through the two outer predrilled holes in the hinge plates (figure 15). Use the 65mm Timbertight screws supplied or something similar. Do not fit tight yet.
6. Carefully close the stairs and check for square. Wedges may be needed at one side of the hinge strip to square the unit in the opening. This may require reopening the stairs and loosening or tightening one of the screws a little.
7. With the stairs open screw through the holes you previously drilled in the side frame into the ceiling frame (figure 16). Do not fit tight yet.
8. Remove temporary cleats.
9. Carefully close the stairs and check that an even amount of the stair frame is showing around the lid. Adjust the side fixings and fit packing as necessary between the stair frame and the ceiling frame. Make sure the sides stay plumb and straight.
10. Now tighten all screws and check again. Fit more screws through the predrilled holes in the hinge plate.

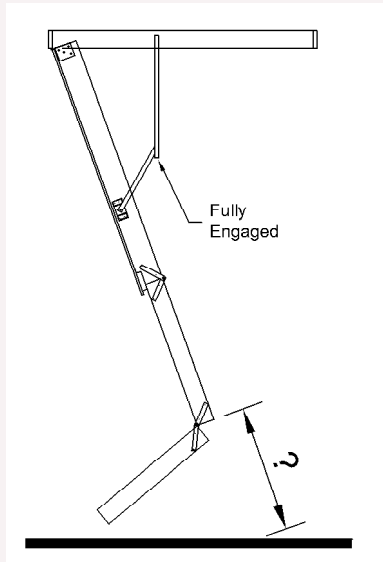

fig 17

11. With the top and middle sections of the stair open and the bottom section tucked in behind, measure the distance from the bottom of the middle section, to the floor at the same angle as the stairs (figure 17). Do this on both sides.
12. Transfer these measurements to the front of the appropriate side of the bottom section of the stair. Mark the cut off back from these points at the same angle as the treads.
 - Measure twice
 - Cut Once

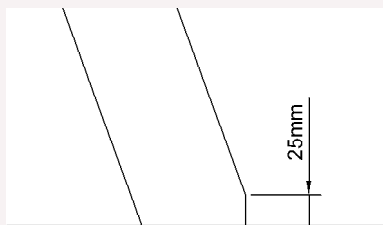
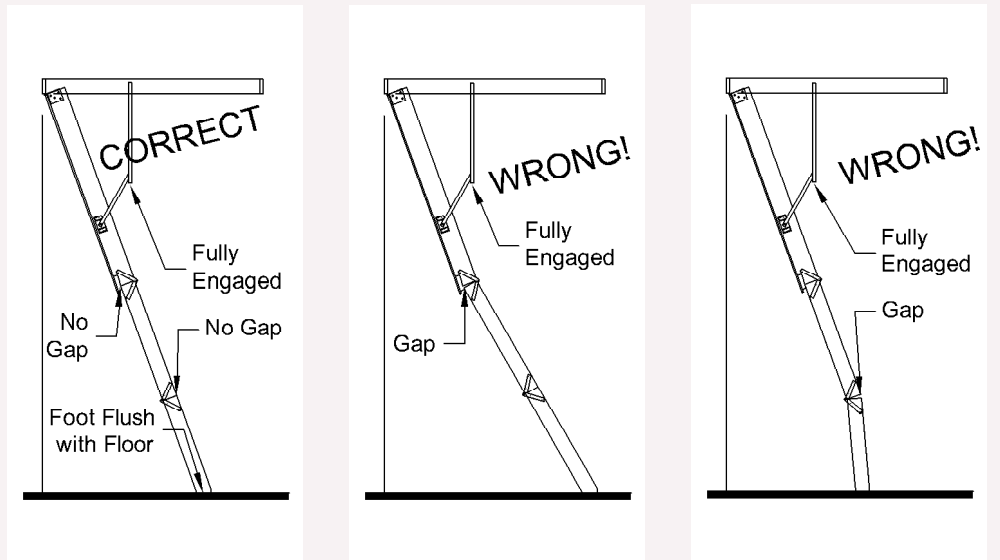

fig 18

13. **Cut the front corners back 25mm** - this can make the stair easier to close and can also prevent damage to the stair if dropped during opening (figure 18).
14. Fix a suitable architrave around the lid leaving a 2-3mm gap or fit "J" channel for flush finish (figure 19).
15. Finish and paint as required.

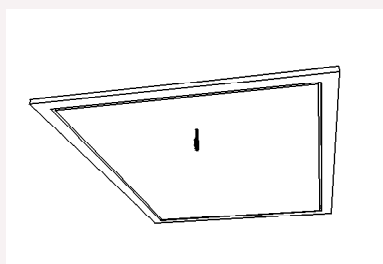

fig 19

These instructions are not intended to be a complete lesson in the installing of attic stairs but a procedural guide to competent trades people or home do it yourself people.

Sellwood Products Limited
 P O Box 35-189
 Browns Bay
 Auckland 0753
 Ph (09) 477-0820
 Fax (09) 479-5687

0800 ATTICS (288 427)
 E-mail sales@sellwood.co.nz
www.sellwood.co.nz