

## SC30 | FANTOZZI

### Installation Instructions

#### Important

Strong springs aid the operation of these ladders! Care must be exercised during installation and operation so these springs are not released in an uncontrolled manner as this could lead to damage to the ladder and personal injury to the operator/installer.

These instructions are not intended to be a complete lesson in the installing of attic ladders but a procedural guide to competent tradespeople or DIYers.

#### Tools Required

Only standard carpentry tools are required.

#### Choosing The Location

When choosing the location for the installation of the attic ladder, a compromise between where you would like it to be located in relation to the floor plan and what is possible in relation to the roof structure may be required. The considerations for this compromise are:

- Choose a location that will give good head room at the top of the ladder;
- Choose a location with good access at the bottom of the ladder;
- Choose a location that will allow for movement around the ladder when in the down position;
- Allowance must be made for the operation of the ladder, as it requires a greater space to open than indicated by the opening in the ceiling (figure 1);

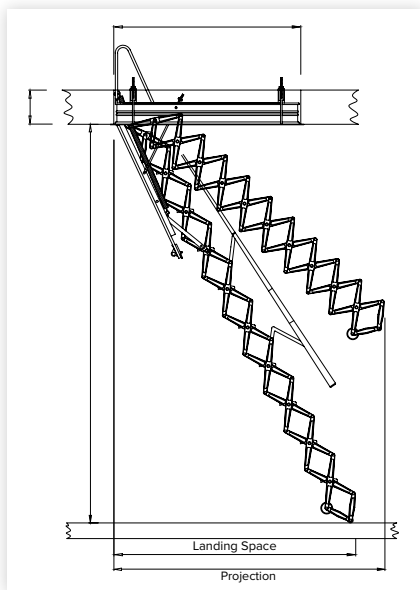

figure 1

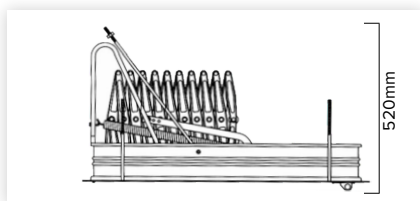

figure 2

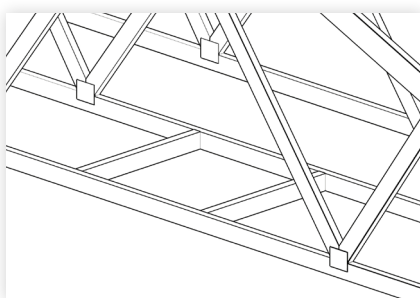

figure 3

Model	Required Opening	Landing space	Projection
SC30 (800 x 600)	800mm x 600	1300mm	1700mm
SC30 (800 x 700)	800mm x 700	1300mm	1700mm

- The area for the opening must be clear of wiring, plumbing and structural members such as beams and trusses with a minimum clear height above the ceiling of 520mm for the SC30 (figure 2).

#### Preparing The Opening

1. The SC30 Attic Ladder is specifically designed to fit lengthways between trusses fitted at 900mm centres (figure 3)
2. Mark out on the ceiling the opening required in the selected position. Then cut out the ceiling lining ensuring that the opening is square.
3. Frame up the opening using minimum **190mm x 45mm** framing timber (H1.2 treated, machine gauged radiata pine or similar). It may be necessary to cut through some existing ceiling joists to achieve the required size. Ensure these are properly supported during and after cutting. The possible arrangement is shown in figure 3.
4. **Do not cut trusses** without engineering approval.

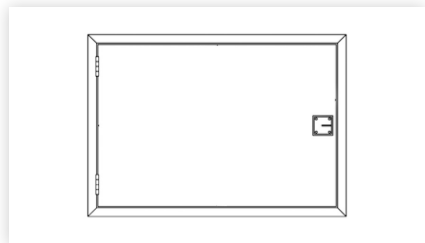

figure 6

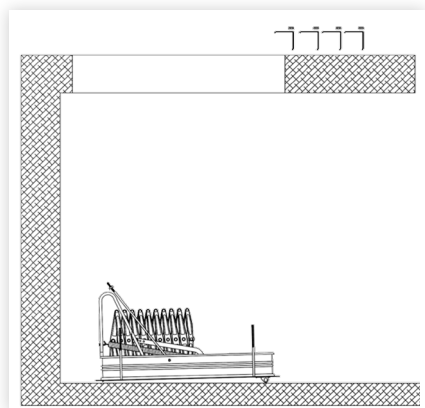

figure 7

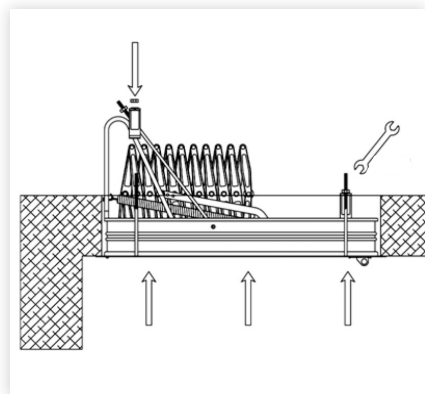

figure 8

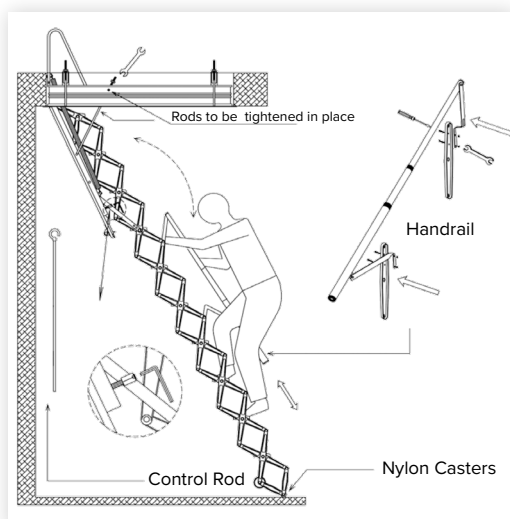

figure 9

## Preparing The Ladder

1. Remove the ladder from its packaging and place it lid down on a bench or saw stool, making sure the hook eye that sticks out on the lid is not taking any weight on the bench. The lid is less likely to get damaged there than laying it on the ground, as well as being better for your back!
2. Take the control rod (the rod with a hook on one end) out of the packaging and lay it aside for now.
3. You may choose to prepare the lid for painting by putting 1-2 coats of primer now as it is easier than later, when the unit is in the ceiling. (Figure 6)

## Installing The Ladder

1. By means of a step ladder, leave the 4 top-fixing brackets with their M10 nuts up into the attic space. (Figure 7)
2. For the next part of the operation there will need to be one person in the attic. Ensure there is good light up there. The ladder is heavy and requires two people to lift it into the opening with the architrave tight to the ceiling. While the ladder is being held in place from below, the person in the ceiling must fit each of the four fixing brackets over each of the four threaded rods and use the M10 nuts to secure them in place. Check the ladder is square in the ceiling and tighten the nuts holding the four brackets.
3. Once the 4 top-fixing brackets are in place and tightened, check that the ladder's frame (in its closed position) is flush on all sides with the ceiling lining. If this is not the case, you have to adjust the ladder from the top, by means of small displacements. Then finally tighten the ladder firmly to the ceiling.
4. Use the control rod to open the ladder from below, by inserting the hook on the control rod into the hook eye on the lid and pulling it open. Then extend the ladder until it reaches the floor. Securely rest the ladders two nylon casters firmly on the floor. Should the ladder need to be adjusted to the stud height of your house, you must adjust the rods, by either screwing down or screwing out both M10 nuts with a spanner. (The nuts must always rest simultaneously on the ratchets). Adjust treads to level. (Figure 9)
5. In the case that you have to fit a handrail on the ladder, you will need to fit it on when the ladder is unfolded. Place the handrail next to the ramp, with the "L" - shaped lever beside the bottom pre-drilled lever and the straight lever. Once the rail is placed correctly on the ladder you will need to use a screwdriver and spanner to bolt the rail to the side of the stair. (Figure 9)
6. The treads may need to be adjusted to level.