

ROOF

ACCESS



- > Retractable Ladder
- > Fixed Ladder
- > Pivotal Ladder
- > Roof Hatch
- > Roof Hatch Barrier
- > Roof Hatch Grabrail

sellwood

ROOF ACCESS

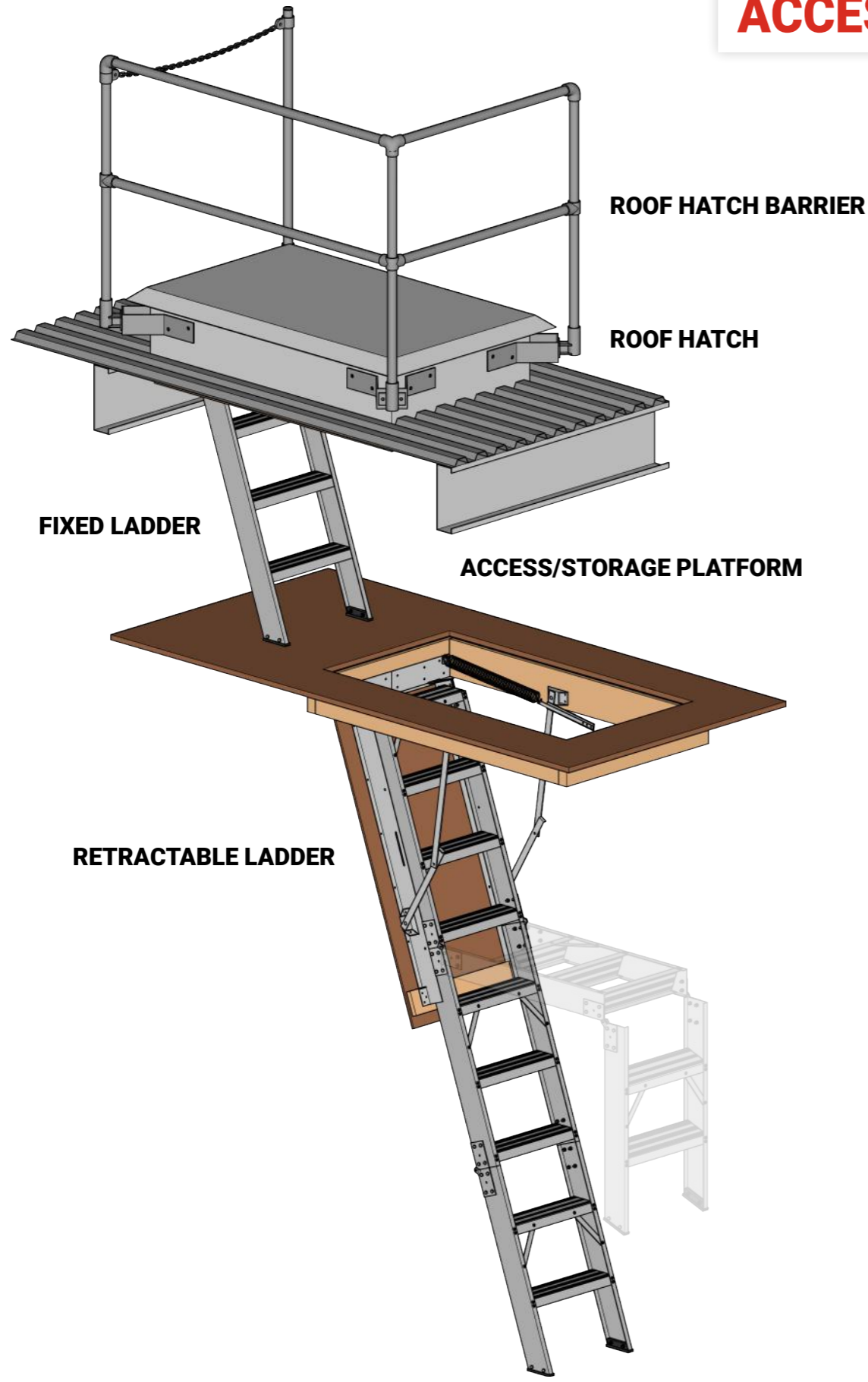

RETRACTABLE LADDER

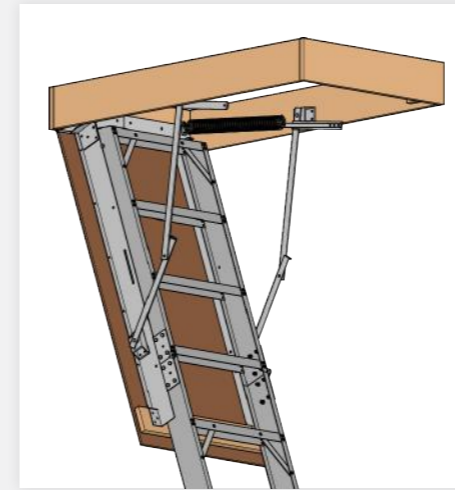

- > 300kg load rating
- > Heavy duty aluminium
- > High quality steelwork
- > Easy slide height adjustment
- > Easy to use

Models
 A25 - 2300mm - 2500mm
 A28 - 2550mm - 2800mm
 A31 - 3000mm - 3160mm
 A34 - 3250mm - 3400mm
 A36 - 3500mm - 3660mm

FIXED LADDER



- > 300kg load rating
- > Heavy duty aluminium
- > Custom built to height
- > Safety handrails
- > Fixed in position

Models
 FLA1000 - up to 1000mm
 FLA1000-2000 - 1000mm - 2000mm
 FLA2000-3000 - 2000mm - 3000mm
 FLA3000-4000 - 3000mm - 4000mm
 FLA4000-5000 - 4000mm - 5000mm

PIVOTAL LADDER



- > 300kg load rating
- > Heavy duty aluminium
- > Custom built to height
- > Safety handrails
- > Stored at 90°

Models
 PLA1000 - up to 1000mm
 PLA1000-2000 - 1000mm - 2000mm
 PLA2000-3000 - 2000mm - 3000mm
 PLA3000-4000 - 3000mm - 4000mm
 PLA4000-5000 - 4000mm - 5000mm

ROOF HATCH

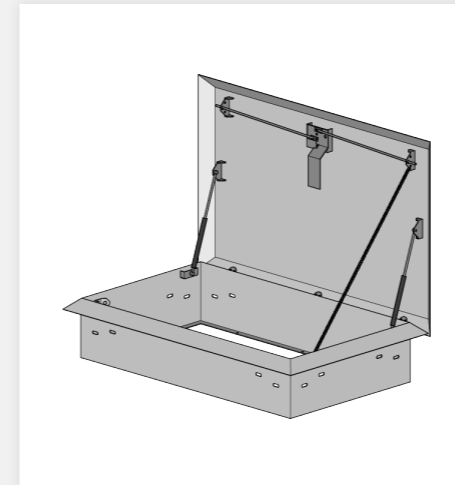

- > Built in 250mm upstand
- > Pneumatic stays
- > Marine grade aluminium
- > 3 Point locking system
- > Powder coated finish

Models
 SRH650900 - 650mm x 900mm
 SRH800800 - 800mm x 800mm
 SRH1150650 - 1150mm x 650mm
 SRH1200900 - 1200mm x 900mm
 SRH1525650 - 1525mm x 650mm

ROOF HATCH BARRIER

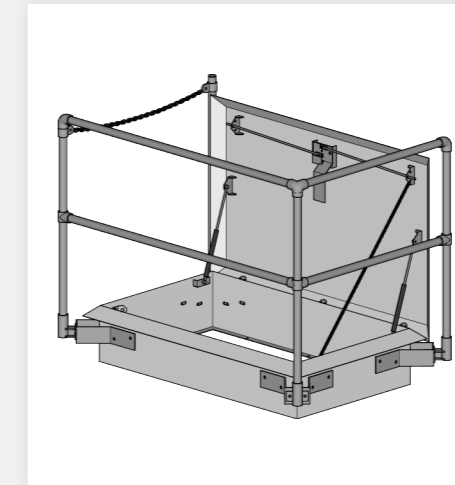

- > Full barrier protection
- > Prevents falls through hatch
- > Bolts to roof hatch upstand
- > Galvanised pipe clamp
- > Easy to install

Models
 RHB650900 - 650mm x 900mm
 RHB800800 - 800mm x 800mm
 RHB1150650 - 1150mm x 650mm
 RHB1200900 - 1200mm x 900mm
 RHB1525650 - 1525mm x 650mm



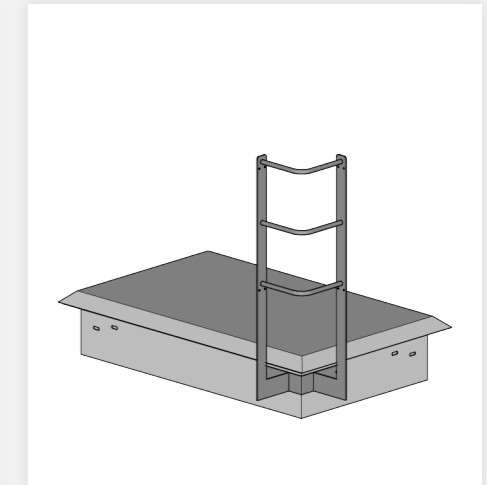

ROOF HATCH GRABRAIL



- > Assists entry / exit
- > Used if barrier not required
- > Bolts to roof hatch upstand
- > Galvanised finish
- > Easy to install



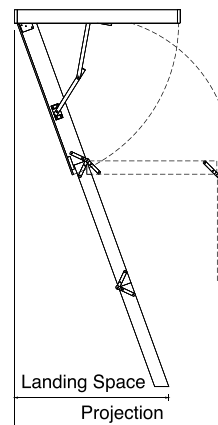

Models
 RHG1000 - 1000mm height

RETRACTABLE LADDER





Range	Commercial				
Model	A25	A28	A31	A34	A36
Ceiling Height	2300-2500	2550-2800	3000-3160	3250-3400	3500-3660
Opening Required	1220x650	1370x650	1440x650	1525x650	1525x650
Max Load	300kg	300kg	300kg	300kg	300kg
Angle	70°	70°	70°	70°	70°
Material	Aluminium	Aluminium	Aluminium	Aluminium	Aluminium
Tread Profile					
Tread Depth	100	100	100	100	100
Ladder Width	425	425	425	425	425
Projection	1467	1589	1801	1892	2027
Landing Space	1092	1201	1332	1420	1514
Handrail	✓	✓	✓	✓	✓
Uses	Residential & Commercial				



FIXED LADDER

Model	FLA1000	FLA1000-2000	FLA2000-3000	FLA3000-4000	FLA4000-5000
Height	up to 1000	1000 - 2000	2000 - 3000	3000 - 4000	4000 - 5000
Max Load	300kg	300kg	300kg	300kg	300kg
Material	Aluminium	Aluminium	Aluminium	Aluminium	Aluminium
Angle	70°	70°	70°	70°	70°
Tread Profile					
Tread Depth	100	100	100	100	100
Ladder Width	446	446	446	446	446
Handrails	-	-	✓	✓	✓

PIVOTAL LADDER

Model	PLA1000	PLA1000-2000	PLA2000-3000	PLA3000-4000	PLA4000-5000
Height	up to 1000	1000 - 2000	2000 - 3000	3000 - 4000	4000 - 5000
Max Load	300kg	300kg	300kg	300kg	300kg
Material	Aluminium	Aluminium	Aluminium	Aluminium	Aluminium
Angle	70° - 90°	70° - 90°	70° - 90°	70° - 90°	70° - 90°
Tread Profile					
Tread Depth	100	100	100	100	100
Ladder Width	446	446	446	446	446
Handrails	-	-	✓	✓	✓

ROOF HATCH

Model	SRH650900	SRH800800	SRH1150650	SRH1200900	SRH1525650
Trim Size	650 x 900	800 x 800	1150 x 650	1200 x 900	1525 x 650
Upstand	250	250	250	250	250
Thickness	2.5	2.5	2.5	2.5	2.5
Lid Thickness	3	3	3	3	3
Hinge Side	Short	Equal	Long	Long	Long
Barrier	RHB650900	RHB800800	RHB1150650	RHB1200900	RHB1525650

Technical drawings, specifications & installation instructions available online