

R28 | R31 | D27 | D31

> INSTALLATION INSTRUCTIONS

IMPORTANT

Strong springs aid the operation of these ladders! Care must be exercised during installation and operation so these springs are not released in an uncontrolled manner as this could lead to damage to the ladder and personal injury to the operator/installer.

These instructions are not intended to be a complete lesson in the installing of attic ladders but a procedural guide to competent tradespeople or DIYers.

TOOLS REQUIRED

The timbertight screws supplied with this ladder require a 5/16" socket for easy installation. This can be used with a 9 volt (or stronger) battery drill or a standard power drill. Apart from this, only standard carpentry tools are required.

CHOOSING THE LOCATION

When choosing the location for the installation of the attic ladder, a compromise between where you would like it to be located in relation to the floor plan and what is possible in relation to the roof structure may be required. The considerations for this compromise are:

- Choose a location that will give good head room at the top of the ladder;
- Choose a location with good access at the bottom of the ladder;
- Choose a location that will allow for movement around the ladder when in the down position;
- Allowance must be made for the operation of the ladder, as it requires a greater space to open than indicated by the opening in the ceiling (figure 1);

Model	Required Opening	Landing space	Projection
R28	1370mm x 650mm	1182mm	1554mm
R31	1370mm x 650mm	1298mm	1733mm
D27	1370mm x 650mm	1601mm	1836mm
D31	1440mm x 650mm	1769mm	2020mm

- The area for the opening must be clear of wiring, plumbing and structural members such as beams and trusses with a minimum clear height above the ceiling of 316mm for R28, R31 and 399mm for D27, D31 (figure 2).

PREPARING THE OPENING

1. Mark out on the ceiling the opening required for the model ladder purchased in the selected position. Cut out the ceiling lining ensuring that the opening is square.
2. Using timber of a compatible size to the existing ceiling framing (ie 90 x 45 or 140 x 45 H1.2 treated, machine gauged radiata pine), frame up the opening. It may be necessary to cut through some existing ceiling joists to achieve the required size. Ensure these are properly supported during and after cutting. Three possible arrangements are shown in figures 3, 4 & 5.
3. **Do not cut trusses** without engineering approval.

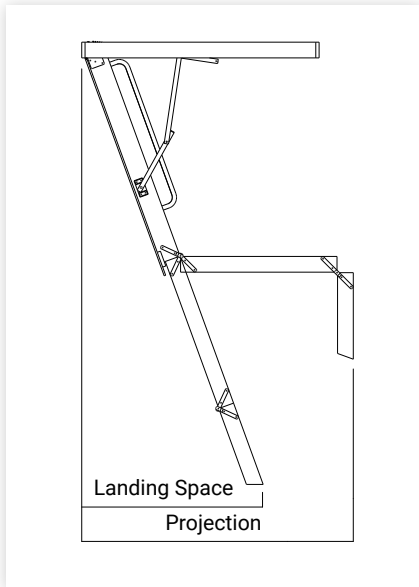

figure 1

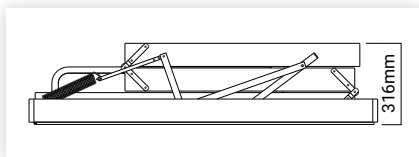

figure 2

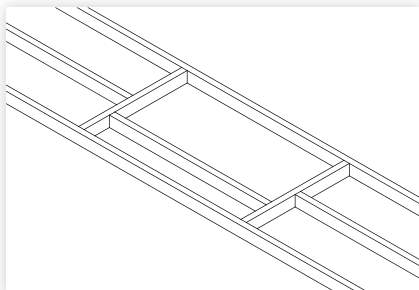

figure 3

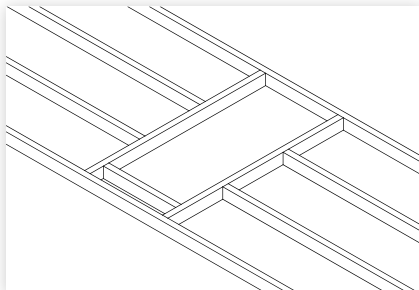

figure 4

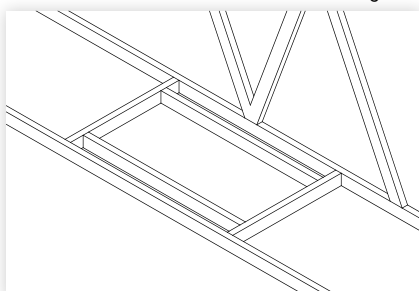

figure 5

sellwood

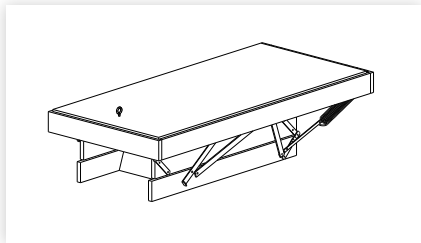

figure 6

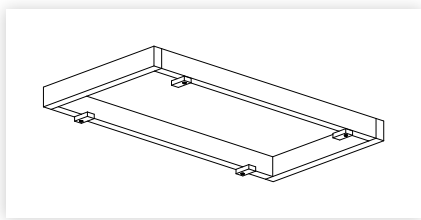

figure 7

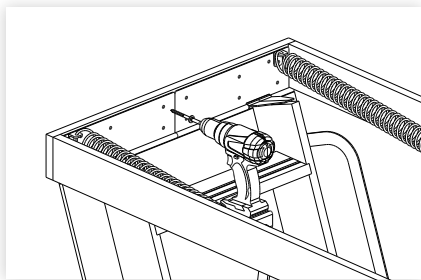

figure 8

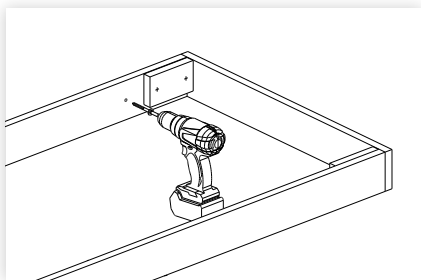

figure 9

PREPARING THE LADDER

1. Remove the ladder from its packaging and place it lid down on a bench or saw stool. The lid is less likely to get damaged there than laying it on the ground, as well as being better for your back!
2. You may choose to prepare the lid for painting by filling and sanding the screw holes now as it is easier than later, when the unit is in the ceiling.
3. Turn the ladder over so the lid is facing up. Fit the screw eye 100mm in from the opening end, midway across the width (figure 6).

INSTALLING THE LADDER

1. Screw four temporary cleats approx 80mm x 40mm into your timber frame (figure 7). Ensure cleats can be rotated.

The cleats must be securely fixed as they carry the full weight of the ladder.

Note: If the ladder is to be installed before the ceiling lining is in place, the cleats must be packed down the thickness of the intended ceiling lining.

2. Lift the ladder through the opening into the attic space. Then lower down squarely into the opening so the lid of the ladder rests on the temporary cleats. This is normally best done from below. For safety and ease it is highly recommended that two people complete this step. Rotate the cleats off the lid and onto the frame of the ladder.
3. Check and confirm there is plenty of frame sitting on the cleats before proceeding further. Adjust if necessary. The ladder must not be allowed to fall, as this could cause **serious physical injury**.
4. Carefully open the ladder, checking that the frame remains securely on the cleats. Adjust if necessary. **Do not put any weight on the ladder at this stage.**
5. From a step ladder or work platform (not the attic ladder), fix the hinge end of the ladder to the ceiling framing through the predrilled holes in the hinge plate (figure 8). Use the timbertight screws supplied. Do not fit tight yet.
6. Carefully close the ladder and check if square. Wedges or packers may be needed at one side of the hinge strip to square the unit in the opening. This may require reopening the ladder and loosening or tightening one of the screws a little.
7. With the ladder open, pre-drill two 6mm holes in each side of the attic ladder frame making sure there is solid timber behind. Screw through the pre-drilled holes into the ceiling frame (figure 9). Do not fit tight yet.
8. Remove temporary cleats.
9. Carefully close the ladder and check that the ladder frame is showing around the lid evenly. Adjust the side fixings and fit packers as necessary between the ladder frame and the ceiling frame. Make sure the sides stay plumb and straight.
10. Now tighten all screws and check again.

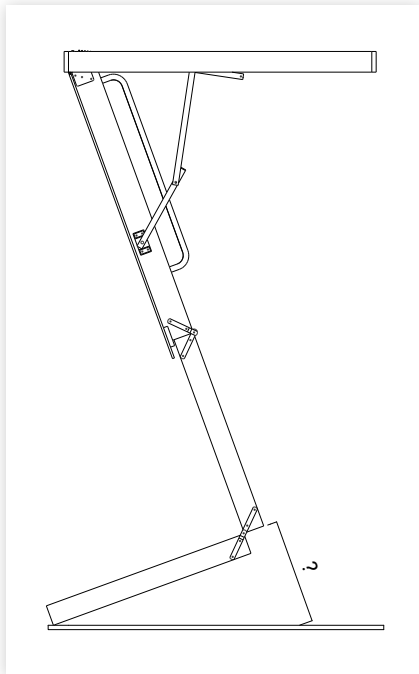

figure 10

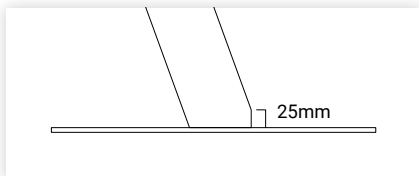

figure 11

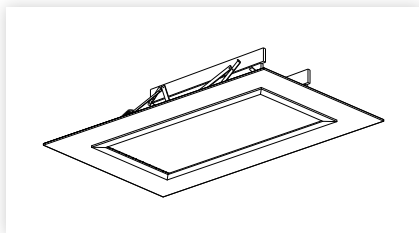

figure 12

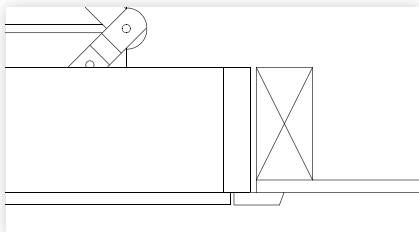

figure 13

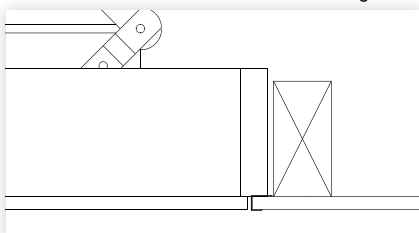

figure 14

ADJUSTING THE LADDER HEIGHT

1. With the top and middle sections of the ladder open and the bottom section tucked in behind, measure the distance from the bottom of the middle section, to the floor at the same angle as the ladder (figure 10). Do this on both sides.
2. Once you have determined the length of '?' (figure 10) transfer these measurements to the front of each side of the bottom section of the ladder. Mark the cut off back from these points at the same angle as the treads.
3. Important: Cut the front corners back 25mm - this can make the ladder easier to close and can also prevent damage to the ladder if dropped during opening (figure 11).

FINISHING THE LADDER

1. Fix a suitable architrave around the lid leaving a 2-3mm gap (figure 12).

Note: The ladder is designed to be installed with the bottom of the frame flush with the underside of the ceiling lining. An architrave will cover the gap between the ladder frame and the ceiling lining while also hiding the edge of the lid from view (figure 13).

Optional: If the ladder is to be installed as the house is being built and before the ceiling lining is fitted you may choose to fit the ladder frame flush with the bottom of the ceiling battens (figure 14). A stopping bead (J mould) is then fitted to the ladder frame and ceiling lining fitted into the stopping bead (J mould) to achieve a square stop finish.

HOW TO LOOK AFTER & USE YOUR SELLWOOD ATTIC LADDER

1. Before climbing, make sure the ladder is fully extended and that there are no gaps between the ladder sections.

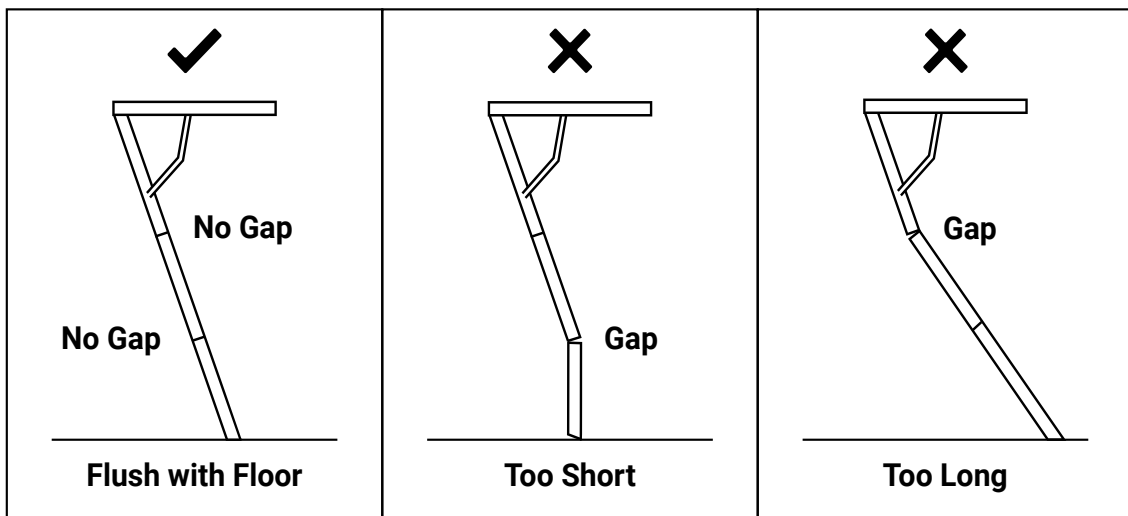

2. If your attic ladder has not been installed in accordance with the manufacturer's installation instructions your warranty may be void.
3. Lubricate all pivot points on your attic ladder at least once a year. If your attic ladder is used more than three times a week, lubricate every 4-5 months.
4. Face the ladder when you are climbing up and down.
5. Do not leave young children unattended while ladder is folded down.
6. If you have any concerns about your Sellwood attic ladder, or it is damaged in any way please call 0800 288 427.