

Roof Hatch Barrier (A)

Installation Instructions



2x Elbow



1x Three Way Top Corner

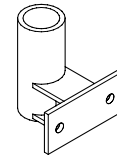

4x Base Flange



2x Short Tee

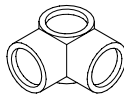

1x Three Way Mid Corner

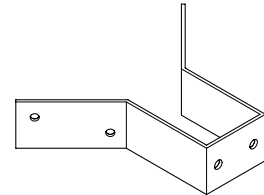

4x Corner Bracket



2x Single Swivel

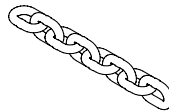

1x Chain

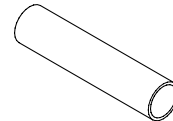

4x Pipe Vertical Posts (980mm)
4x Pipe Side Rails



1x Post Cap

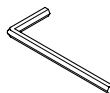

1x Allen Key



1x Bag Fixings

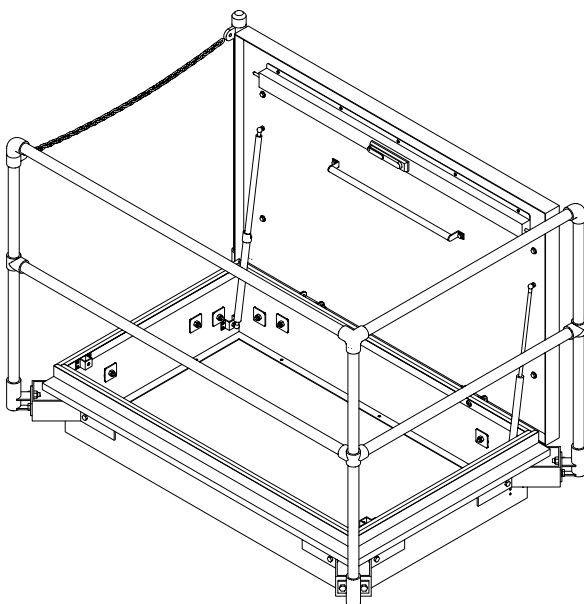

Bolt base flanges onto corner brackets then bolt onto roof hatch.

Insert vertical posts into base flanges.

Feed short tees & three way mid corner with side rails attached over the vertical posts & fix at mid point.

Feed single swivels over vertical posts at entry/exit side & position about 30mm from top of post then attach chain.

Feed the elbows & three way top corner over the vertical posts with side rails attached.

Place the post cap over single vertical post.

Make sure all pipe clamps & fixings are securely fastened.

Roof Hatch Barrier (B)

Installation Instructions



4x Elbow

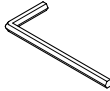

1x Allen Key

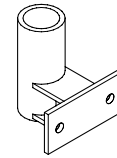

4x Base Flange



4x Short Tee

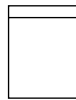

1x Bag Fixings

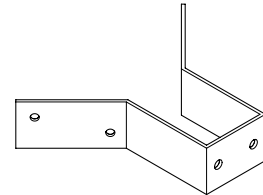

4x Corner Bracket



2x Single Swivel

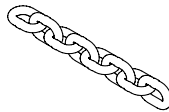

1x Chain

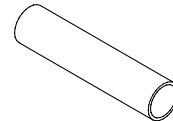

4x Pipe Vertical Posts (980mm)
4x Pipe Side Rails

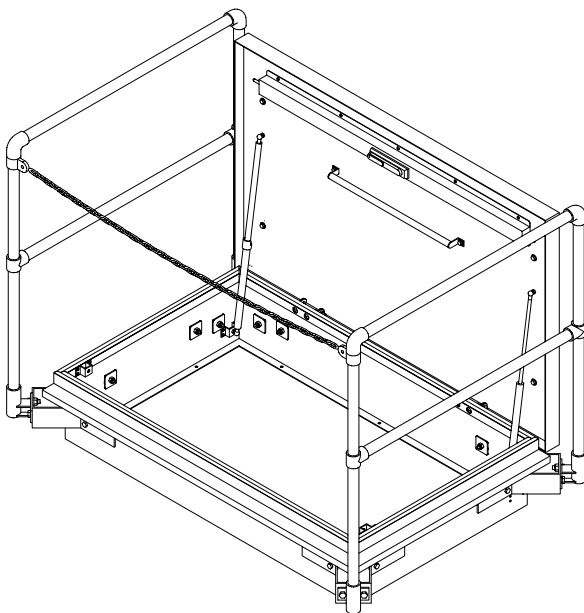

Bolt base flanges onto corner brackets then bolt onto roof hatch.

Insert vertical posts into base flanges.

Feed short tees with side rails attached over the vertical posts & fix at mid point.

Feed single swivels over vertical posts at entry/exit side & position about 30mm from top of post then attach chain.

Feed the elbows over the vertical posts with side rails attached.

Make sure all pipe clamps & fixings are securely fastened.