



Q24

Attic Stairs

Installation Instructions for model Q24

Important

Strong springs aid the operation of these stairs! Care must be exercised during installation and operation so these springs are not released in an uncontrolled manner as this could lead to damage to the stair or personal injury to the operator/installer.

Tools Required

The Timbertight screws supplied with this stair require a 5/16" socket for easy installation. This can be used with a 9 volt (or stronger) battery drill or a standard power drill. Apart from this only standard carpentry tools are required.

Choosing the Location

When choosing the location for the installation of the attic stair a compromise between where you would like it to be located in relation to the floor plan and what is possible in relation to the roof structure may be required. The considerations for this compromise are set out below.

1. Choose a location that will give good headroom at the top of the stairs.
2. Choose a location with good access at the bottom of the stairs.
3. Choose a location that will allow for movement around the stair when in the down position.
4. Allowance must be made for the operation of the stairs, as they require a greater space to open than indicated by the opening in the ceiling (figure 1). *All dimensions in mm.*

Model	Required Opening	Landing Space	Projection
Q24	835 x 650	1050	1300

5. The area for the opening must be clear of wiring, plumbing and structural members such as beams and trusses with a minimum clear height above the ceiling of 420mm (figure 2).

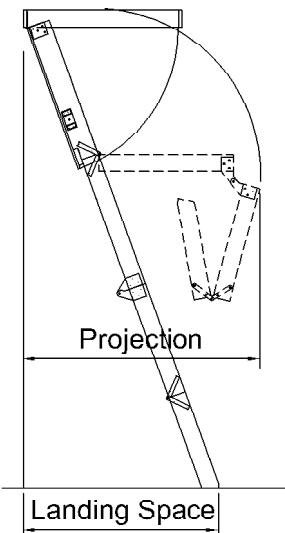

fig. 1

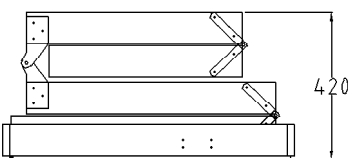

fig. 2

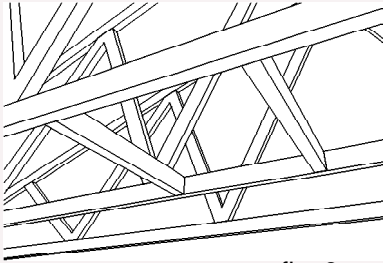

fig. 3

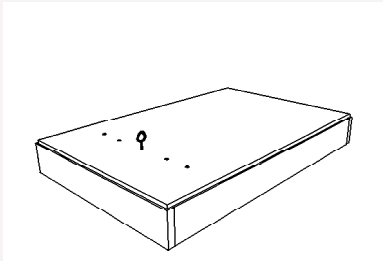

fig. 4

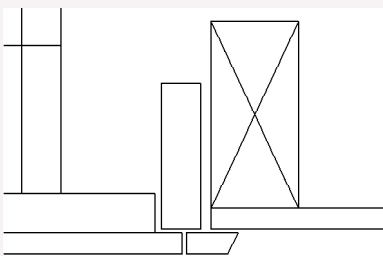

fig. 5

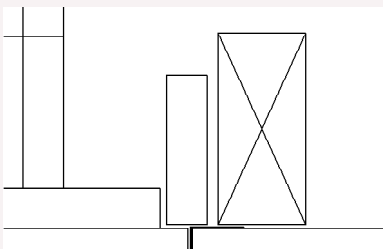

fig. 6

Preparing the Opening

1. The Quad 24 Stair is specifically designed to fit lengthways between trusses fitted at 900mm centres (figure 3). It is only suitable where the height of the ceiling is no more than 2440mm.
2. Mark out on the ceiling the opening required in the selected position. Then cut out the ceiling lining ensuring that the opening is square.
3. Using timber of a compatible size to the existing ceiling framing, ie 100 x 50 or 150 x 50 H1 treated, machine gauged radiata pine, frame up the opening. It may be necessary to cut through some existing ceiling battens to achieve the required size. Ensure these are properly supported during and after cutting.

Preparing the Stairs

1. Remove the stair from its packaging and place it lid up on a bench or saw stool. It's less likely to damage the lid there than laying it on the ground as well as being better for your back!
2. You may choose to prepare the lid for painting by filling and sanding the screw holes now as it is easier now than later, when the unit is in the ceiling.
3. Fit the screw eye which is taped to the operating rod to the lid 60mm in from the opening end, midway across the width (figure 4).

Installing the stairs

Note; The stairs are designed to be installed with the outside frame flush with the underside of the ceiling lining. An architrave will cover the gap between the stair frame and the ceiling lining while also hiding the edge of the lid from view (figure 5).

Optional; If the stair is to be installed as the house is being built and before the ceiling lining is fitted you may choose to fit the stair frame flush with the bottom of the ceiling battens. A "J" channel is then fitted to the stair frame and ceiling lining fitted into the "J" frame to achieve a square stop finish (figure 6).

1. Screw two temporary cleats that are the full width of the opening to the ceiling (figure 7). Fix one cleat at the hinge end protruding 15mm into the opening. The other, at the opening end, must protrude 15mm into the opening also. The distance between these cleats must be $L + 10\text{mm}$ as seen in figure 8.

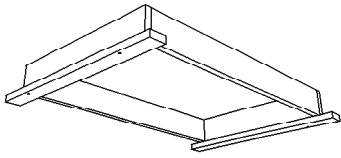

fig. 7



fig. 8

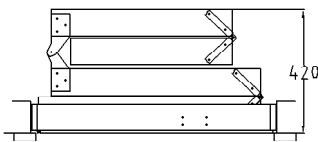

fig. 9

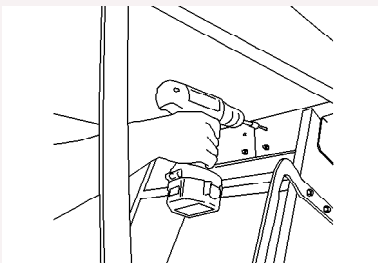

fig. 10

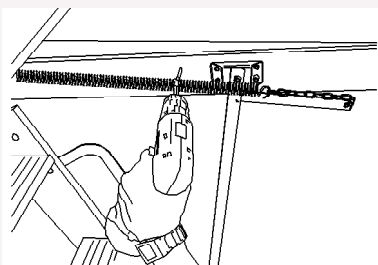

fig. 11

The cleats must be securely fixed as they carry the full weight of the stairs

Note; If the stairs are to be installed before the ceiling lining is in place, the cleats must be packed down the thickness of the intended ceiling lining unless a "J" channel is being used.

2. Lift the stairs through the opening into the attic space. Then lower them down squarely into the opening so the frame of the stair rests on the temporary cleats (figure 9). This is normally best done from below and can be done by one person, but it is very much easier and safer with two people.
3. Check and confirm there is plenty of frame sitting on the cleats before proceeding further. Adjust if necessary. **The stairs must not be allowed to fall, as this could cause SERIOUS PHYSICAL DAMAGE.**
4. Carefully open the stair, checking that the frame remains securely on the cleats. Adjust if necessary. **DO NOT PUT ANY WEIGHT ON THE STAIR AT THIS STAGE.**
5. From a step ladder or saw stool or similar (not the attic stair), fix the hinge end of the stair to the ceiling framing through the two outer predrilled holes in the hinge plates (figure 10). Use the 65mm Timbertight screws supplied or something similar. Do not fit tight yet.
6. Carefully close the stairs and check for square. Wedges may be needed at one side of the hinge strip to square the unit in the opening. This may require reopening the stairs and loosening or tightening one of the screws a little.
7. With the stairs open screw through the holes in the side frame into the ceiling frame (figure 11). Do not fit tight yet.
8. Remove temporary cleats.
9. Carefully close the stairs and check that an even amount of the stair frame is showing around the lid. Adjust the side fixings and fit packing as necessary between the stair frame and the ceiling frame. Make sure the sides stay plumb and straight.
10. Now tighten all screws and check again. Fit more screws through the predrilled holes in the hinge plate and the end frame. Pack where necessary.

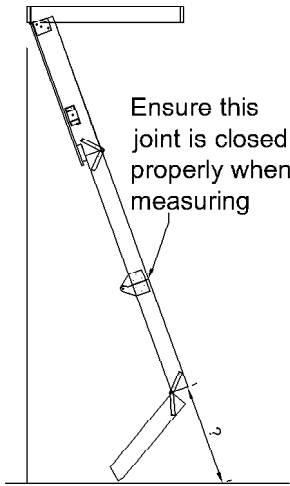

fig. 12

11. With the top and middle sections of the stair open and the bottom section tucked in behind, measure the distance from the bottom of the middle section, to the floor at the same angle as the stairs (figure 12). Do this on both sides.
12. Transfer these measurements to the front of the appropriate side of the bottom section of the stair. Mark the cut off back from these points at the same angle as the treads.
 - Measure twice
 - Cut Once
13. **Cut the front corners back 25mm** - this can make the stair easier to close and can also prevent damage to the stair if dropped during opening (figure 13).
14. Fix a suitable architrave a round the lid leaving a 2-3mm gap or fit "J" channel for flush finish (figure 14).
15. Finish and paint as required.

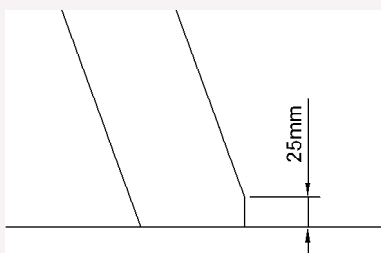
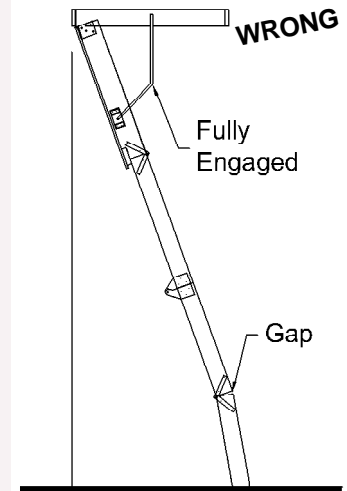
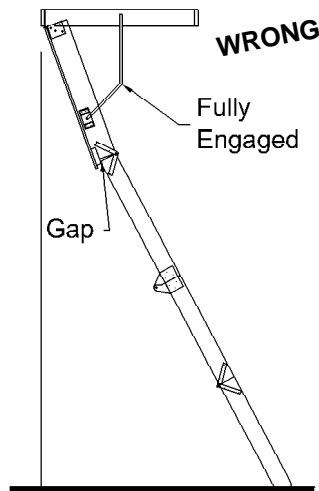
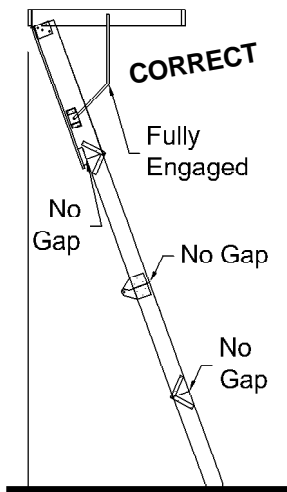

fig. 13

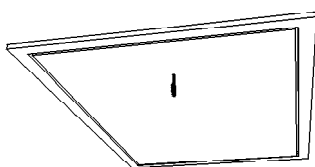

fig. 14

These instructions are not intended to be a complete lesson in the installing of attic stairs but a procedural guide to competent trades people or home do it yourself people.

Sellwood Products Limited
 P O Box 35-189
 Browns Bay
 Auckland 0753
 Ph (09) 477-0820
 Fax (09) 479-5687

Toll free 0800 ATTICS (288 427)
 E-mail action@sellwood.co.nz
www.sellwood.co.nz